

# balterio

Quality European Laminate Flooring



**Timelessly  
Modern.**

*Find the floor that fits  
your personality*

1

### Strength & durability

#### Wear-resistant surface layer, HDF Core

- Surface of melamine resin reinforced with aluminium oxide - one of the hardest mineral compounds known to man. Able to resist staining, fading, surface moisture, scratches, cigarette burns, stiletto marks and general wear and tear.
- Core made from HDF (high density fibreboard), as opposed to the MDF core (medium density fibreboard) that many competitors use. HDF is a stronger and more stable board, more resistant to punctures from sharp objects or sudden pressure and much less likely to swell if in contact with water.
- Balterio laminate flooring is much harder and more wear-resistant than real wood flooring.



### Low repeat pattern

For a more authentic looking floor Balterio laminate flooring has a very low repeat pattern ratio compared to many other laminate brands. Patterns are repeated as little as every 10 boards, ensuring your floor looks as authentic as possible.

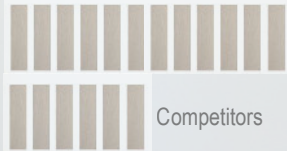

2



### European style & quality

Quality product made in Belgium  
Balterio laminate flooring is made in Belgium and is a well established brand worldwide. The Balterio R&D team follow the latest flooring trends globally and use advanced technologies to replicate the look of real wood floors.

4



### Environmentally conscious

Balterio cares about the environment  
All Balterio laminate floors are PEFC-certified to ensure the preservation of our forests. For each tree that is used in the production process, another one is planted.  
Balterio laminate floors contain 10 times less formaldehyde than the required European Standards.  
Balterio have an 'Embrace the future' program in place, with a focus on increasing the efficiency of their production process and product innovation while decreasing the use of resources and the impact on the environment.



8

3

### Low maintenance

Quick and easy to clean

Simply vacuum and give your floor a light mop with slightly damp pad using an approved laminate floor cleaner, and your Balterio laminate floor is sure to keep its lovely appearance for years. Please note we do not recommend the use of steam mops on this flooring.

### Underfloor heating

Great for under floor heating

Balterio laminate floors have 3x better heat conduction ratings than the industry requirement and are suitable for use with most under floor heating systems.

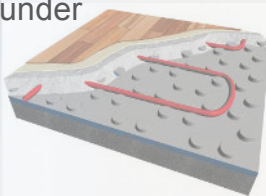

5

### Easy to install

Unique joint systems that make installation simple. Balterio laminates must be floated on underlay. Balterio's unique and award-winning locking systems ensure that installing your laminate floor is a breeze. Watch the installation video at [www.balterio.com](http://www.balterio.com) or scan the QR code for more information.



7

### Long-lasting warranties

For your peace of mind

Balterio offers a lifetime\* warranty on integrity of the click joint systems. Balterio also offers the market both residential and commercial warranties. Most competitors only provide residential warranties. \* max. 33 years



6





**LINNEN OAK**  
FLPL-BAGW-LI



**BOURBON OAK**  
FLPL-BAGW-BO



**BRIGHT OAK**  
FLPL-BAGW-BR



**VENN OAK**  
FLPL-BAGW-VE



**SEASHELL OAK**  
FLPL-BAGW-SE



**SIENNA OAK**  
FLPL-BAGW-SI

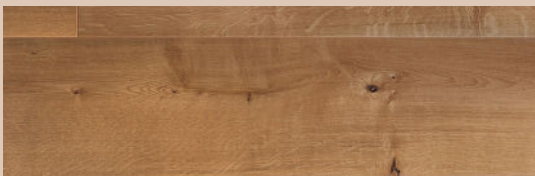

**CLASSIC OAK**  
FLPL-BAGW-CL



kitchens



bedrooms



living areas



wet areas



light commercial



# GRANDE

high definition, extra wide planks in a range of classic tones.

9mm H 240mm W 2050mm L

Parquet Bevel 4V

2.952 m<sup>2</sup>/pack



# OASIS

luxurious flooring to create realistic timber looks in every home.

8mm H 192mm W 1261mm L 4 sided pressed bevel 2.179 m<sup>2</sup>/pack

**BURLINGTON OAK**  
FLPL-WLOA-BU

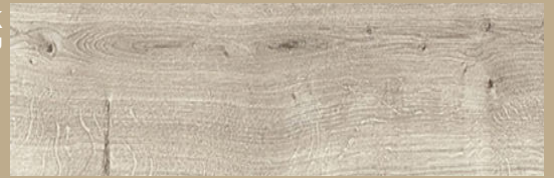

**CABIN OAK**  
FLPL-WLOA-CA



**CAMEL OAK NATURAL**  
FLPL-WLOA-CM



**COPPER BLOND OAK**  
FLPL-WLOA-CO



**MEDIEVEL BROWN OAK**  
FLPL-WLOA-ME



**MISTY OAK**  
FLPL-WLOA-MI



**ROTAN OAK**  
FLPL-WLOA-RO



**WARM WHITE OAK**  
FLPL-WLOA-WA



**uniclic**  <sup>®</sup>



kitchens



bedrooms



living areas



wet areas



light commercial



**SPRING SNOW OAK**  
FLPL-WLOW-SP



**HUSK OAK**  
FLPL-WLOW-HU



**URBAN OAK**  
FLPL-WLOW-UR



**STERLING OAK**  
FLPL-WLOW-ST



**TAYLOR OAK**  
FLPL-WLOW-TA



**CAMEL OAK BEIGE**  
FLPL-WLOW-CA

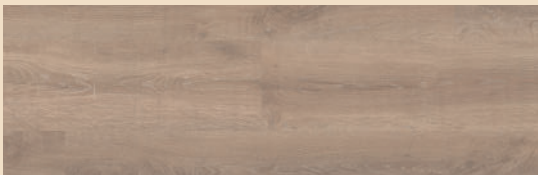

**BANDIT OAK**  
FLPL-WLOW-BA



**BLOND OAK**  
FLPL-WLOW-BL



kitchens



bedrooms



living areas



wet areas



light commercial





# OASISWIDE

dramatic wide planks for a statement floor  
in a neutral palette.

8mm H 244mm W 1261mm L

4 sided pressed bevel

2.4615 m<sup>2</sup>/pack



**SANDSTORM OAK**  
FLPL-BAQV-SA



**MONTANA OAK**  
FLPL-BAQV-MO



**MACADAMIA OAK**  
FLPL-BAQV-MIA



**GOLDEN CHESTNUT**  
FLPL-BAQV-GO



**HONEY BLOND CHESTNUT**  
FLPL-BAQV-HB

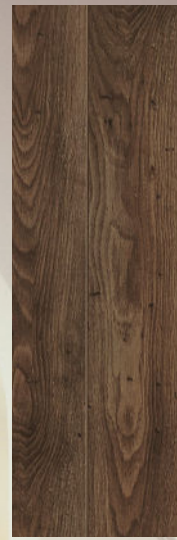

**GUNSMOKE CHESTNUT**  
FLPL-BAQV-GU



**SUNSET OAK**  
FLPL-BAQV-SU



**SHERLOCK OAK**  
FLPL-BAQV-SH



# QUATTRO VINTAGE

aged styles to create character in the  
modern home

8mm H 190.5mm W 1.257m L

Micro V-groove 4 sides

2.1551 m<sup>2</sup>/pack

# floorMuffler®

A high performance underlay that not only reduces sound transfer, but provides a moisture barrier, thermal properties and superior compression strength to provide greater longevity to your flooring.



## SOUNDGUARD 2MM UNDERLAY

10m x 1.0m x 2mm - Covers 10m<sup>2</sup>  
 25m x 1.0m x 2mm - Covers 25.0m<sup>2</sup>  
 Outstanding performance with great sound reduction and heavy duty moisture barrier

## EVA 2.8MM UNDERLAY

Dimensions: 10m x 1.1m – Covers 11m<sup>2</sup>  
 Dimensions: 25m x 1.1m – Covers 27.5m<sup>2</sup>  
 High performance with integral damp proof membrane



floorMuffler US  
 available in a 10m and 60m roll



floorMuffler LVT  
 available in a 10m roll



## SOUNDGUARD EXTREME 2.5MM UNDERLAY

10m x 1.0m x 2.5mm – Covers 10m<sup>2</sup>  
 With a nylon reinforced backing it offers Incredibly high effectiveness at reducing footfall noise and sound transfer.

**IXPE 3MM UNDERLAY**  
 Dimensions: 10m x 1.1m – Covers 11m<sup>2</sup>  
 Dimensions: 25m x 1.1m – Covers 27.5m<sup>2</sup>  
 Outstanding performance with compression strength, sound and moisture protection

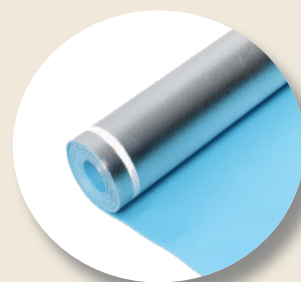

Refer to website for further details  
[woodlandlifestyle.com/product-range/underlay](http://woodlandlifestyle.com/product-range/underlay)

# UNDERLAY & ACCESSORIES

## 3 in 1 Trims

To complement the Laminate Flooring range, the colour matched 3 in 1 profile serves a multi-purpose of finishings, colour matched for all the our laminate colours. 1.85m long

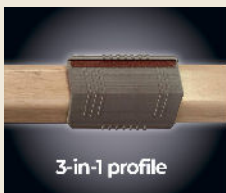

3-in-1 profile

3 applications in 1 single product  
 Delivered with cutter

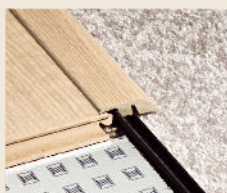

1. Adaptor profile  
 1850 x 43.7 x 12.5 mm

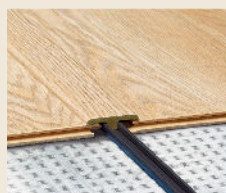

2. Expansion profile  
 1850 x 33.4 x 10.5 mm



3. End profile  
 1850 x 33.4 x 12.5 mm

## Aluminium C Channels

To complement most flooring ranges, the aluminum trims are a tidy finish to cap steps or transition to another flooring type.

2.7m long  
 Available in sizes suited for a 7-8mm floor and a 14 - 15.5mm floor.

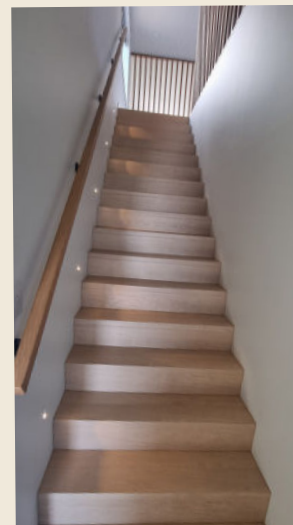
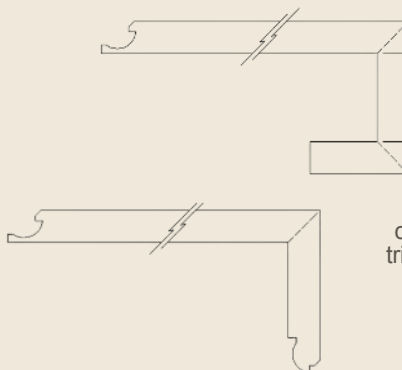

## Custom Stair Trims

For a seamless install on staircases, we have developed custom trims to match our laminate ranges.

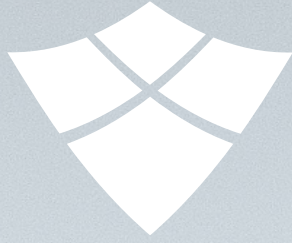

**WOODLAND**  
LIFESTYLE

**balterio**



Distributed in New Zealand by Woodland Lifestyle  
+64 9 308 7948 | [hello@woodlandlifestyle.com](mailto:hello@woodlandlifestyle.com)  
[woodlandlifestyle.com](http://woodlandlifestyle.com)